

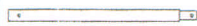

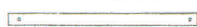











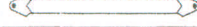
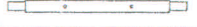







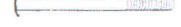

Assembly Manual Parts List

12'x20'x8' Peak Style Garage

Model# 71434
English

Includes: #101113 (Basic Frame) #111113 (Gray Cover Kit)

Description of Parts	Part #	Qty.
 Cross Rail Swedged 50 3/8"L	2030	11
 Cross Rail Plain Ends 48 1/2"L	2031	2
 Cover Rail Plain Ends 45 3/4"L	10110	10
 Swedged Rafter Pole 60"L	10125	12
 Swedged Upright Tube 67 3/4"L	10126	8
 Cross Rail Swedged 48 7/8"L	10133	1
 Cross Rail Plain Ends 47"L	10134	1
 Wind Brace(Flat Ends) 62.7"L	10135	2
 Corner Upright Tube 57 3/4"L	10127	4
 Side Bend Tube	10132	12
 Top Bend Tube	10131	4
 3-way Top Connector	10121	2
 Bent Corner Leg	10128	4
 Cap	10150	16
 Temporary 30" Auger Anchors Cable - 1' Lengths Cable Clamps	822	6
 Base Feet	10113	8
 Ratchet	10040	8
 4-Way Cover Rail Clamp	10111	16
 3-Way Cover Rail Clamp	10112	8
 1/4" x 3" Round Head Bolt	669	4
 1/4" x 3" Bolt	10210	12
 1/4" x 2" Bolt	10114	52
 1/4" x 1 5/8" Bolt	10115	22
 1/4" Nut	1010	90
 Cover (Gray)	1A1113	1
 2-Zipper Door	1E1013	2
 ShelterLock Stabilizer Block	800260	12



Before You Start

2 Persons recommended for assembly
Estimated assembly time = 3 hours

Recommended Tools

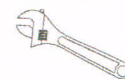

Adjustable Wrench
or

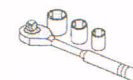

Socket Set with
7/16" Socket



Rubber Mallet



Rope (The length
of Shelter Plus 10')



www.shelterlogic.com
1-800-524-9970
Canada 1-800-559-6175

150 Callender Road
Watertown, CT 06795

Manufactured Under
U.S. Patents
D415,571 D409,310
D430,306 D414,564
Other Patents Pending

PAGE 1
04-71434-OB 08/15/07

12'W x 8'H Peak Style Frame Assembly

Please read and understand instructions completely before assembly.

Layout out frame parts as shown and match up items with quantity to make sure no parts are missing.



ATTENTION:
FOR MISSING OR REPLACEMENT PARTS OR QUESTIONS, PLEASE CONTACT
CUSTOMER SERVICE:
1.800.524.9970
CANADA 1.800.559.6175

Assembly Reference #	Mfg. Part #	Assembly Reference #	Mfg. Part #
1	10131	12	10135
2	10121	13	10110
3	10132	14	10111
4	10125	15	10112
5	10126	16	669
6	10127	17	10210
7	10128	18	10114
8	10133	19	10115
9	2030	20	10113
10	10134	21	800260
11	2031		



Basic Frame Assembly

NOTE: FRAME EXTENSION KIT

12'x20'x8' is the base frame dimension. Your model may have more middle ribs than shown in the illustration on pg.2. You will receive one extra rib for every extra 4 ft. of building length that you purchase. The basic frame assembly will remain the same. The cover will be the correct size for the length of the building. Part #10223 is not required if your building is only 8' tall.

STEP 1: PLOTTING THE FRAME

Fig. 1

Before building your shelter, you should choose a flat area on your property and plot your shelter.

1. Stake out the area for the shelter in the desired spot. The width of the area should be at least equal to the width of the shelter and the length should be equal to the length ("L") of the shelter Fig. 1.
2. To be sure the staked area is square tie a rope diagonally from corner to corner.
3. Measure from where the two ropes intersect each other to all 4 corners. This measurement should be the same. If they are not equal the stakes need to be adjusted until the width, length and inside measurements are correct.

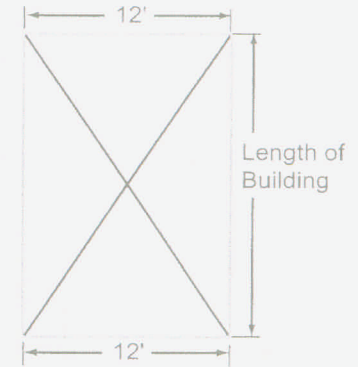

Fig.1

STEP 2: ASSEMBLE END RIBS

Fig. 2

Assemble end ribs as shown in Fig. 2. Securely fasten all of the joints with the hardware indicated.

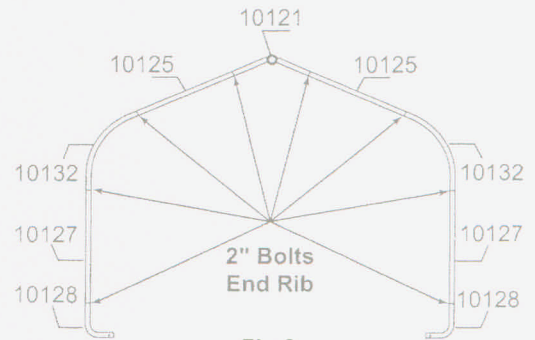

Fig.2

STEP 3: ASSEMBLE MIDDLE RIBS

Fig. 3

Assemble all of the middle ribs as shown in Fig. 3. Securely fasten all of the joints with the hardware indicated.

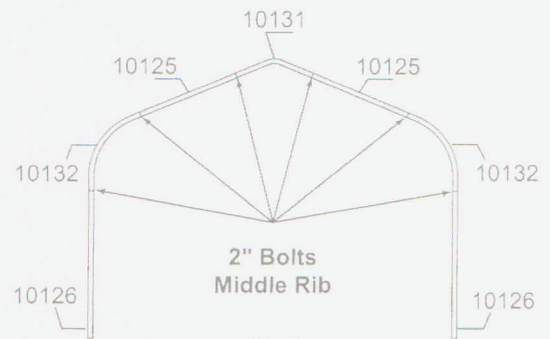

Fig.3

STEP 4: INSTALL SIDE RAILS AND SHELTERLOCK™ STABILIZER BLOCKS

Fig. 4

With help move the first end rib into the desired staked area. Place the ShelterLock on the upright as shown in Fig. 4. From the outside of the rib insert the bolt through the upright and then through the ShelterLock. Place the plain end of the side rail over the bolt and nest it into the ShelterLock. Install the nut onto the bolt and tighten. Repeat these steps for the opposite side and all of the remaining ribs. The side rails for the last rib will have two plain ends.

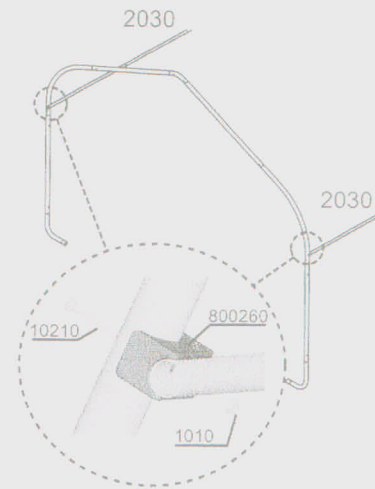

Fig. 4

STEP 5: INSTALL WIND BRACES

Fig. 5

Take the wind brace and attach it between the end rib and the first middle rib as shown in Fig. 5. **Any attachments at the cross rails should be made on the very inside of the cross rail.**

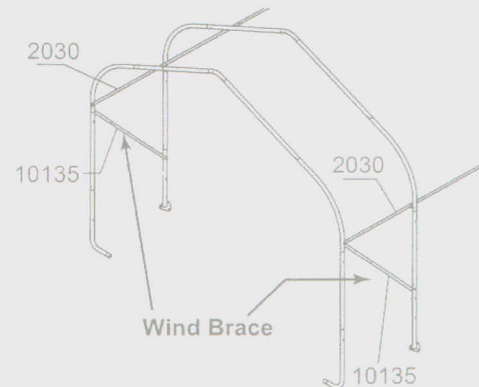

Fig. 5

STEP 6: INSTALL TOP RAIL

Fig. 6

Place the first top rail over the pipe on the top end connector Fig. 6. The same cross rail should lay on top of the first middle rib as with all of the middle ribs. Secure the rails to the frame with the hardware indicated in Fig 6. The top rail attached to the last rib will be installed over the pipe on the top end connector.

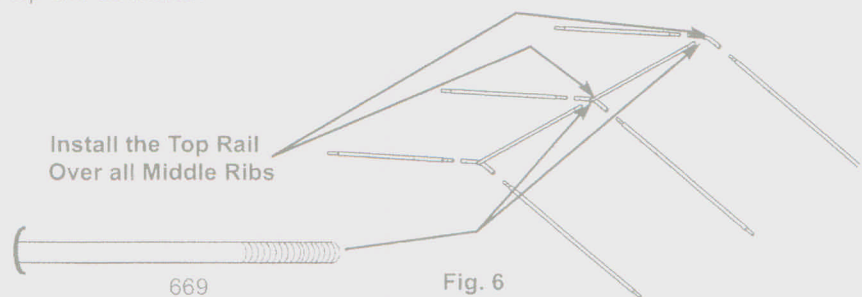

Fig. 6

STEP 7: SECURE BASE FEET

Fig. 7

Depending on the model you have purchased, your base feet will either fit onto the outside of the leg pole or slide into the bottom of the leg pole. After installing the base feet line up the holes in the leg to the holes in the feet and secure with the hardware indicated in Fig. 7.

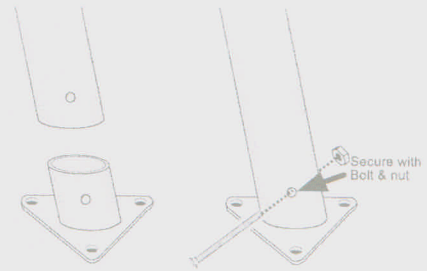

Fig. 7

STEP 8: INSTALL AUGER ANCHORS

Fig. 8

Using a $\frac{3}{4}$ " pipe or steel rod (a car tire iron works also) placed through the eyelet of the auger; screw the anchor into the ground. Start at the corners of the shelter and space the remaining anchors evenly along the length of the shelter. Screw the anchor into the ground until the eyelet is sticking out of the ground by 1-2" so it can be anchored to the legs. Wrap the cable provided through the eyelet of the anchor and around the frame as indicated in Fig. 8. Secure the cable with the clamp(s) provided.

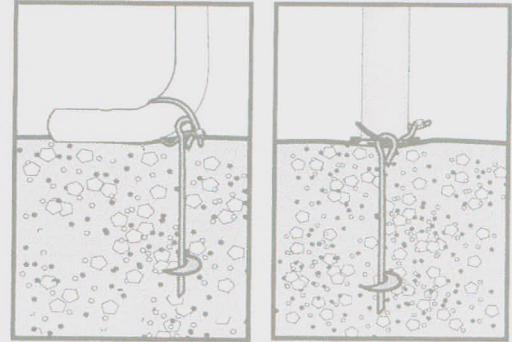

Fig. 8

STEP 9: END PANEL INSTALLATION

Fig. 9A, 9B & 9C

Hold the end panel at the top center with the white inner surface facing the inside of the shelter (if you have a white shelter the inner surface has the visible weld seams). Carefully remove the top rail from the top bend and place the webbing in between the two. The top rail should pass through the loop of the webbing. Replace the top rail onto the top bend and secure it with the hardware indicated in Fig. 9A, 9B.

Remove the nut from the side rail and carefully pull the side rail away from the ShelterLock (the rail only needs to be pulled away enough to pass the webbing through the connection). **If this connection has the wind brace on it remove the wind brace end before pulling the side rail.** When the webbing is through replace the side rail, and the cross rail if necessary Fig 9C. Replace the nut and tighten. Repeat this for the other side.

Locate where the webbing exits the pocket on each side of the end panel. Pull the webbing carefully to remove the slack from the end panel. Be careful not to pull the webbing through the other side of the panel. Install the "S"-hook from the ratchet into the leg of the shelter Fig 9D. Insert the webbing into the spindle of the ratchet and pull tight. Wind the ratchet enough so that the webbing overlaps itself. Repeat the process on the other side of the panel. Position the end panel so that it is centered on the building. Tighten the ratchets, alternating from one side to the other, until the end panel is tight. Repeat these steps on the other end of the building.

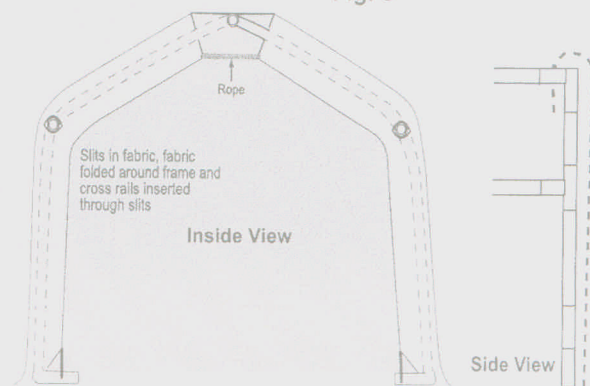

Fig. 9A

Fig. 9B



Fig. 9C



Fig. 9D

STEP 10: INSTALLING THE COVER ON THE FRAME: Fig. 10A, 10B, 10C & 10D

1. Lay the cover on the ground next to the frame with the inside of the cover (the side with the pipe pockets) facing down and the webbing on the front and rear of the corner of the building. Position the cover so that it is centered on the frame, front to back. Fig. 10A

2. Fold over the side closest to the frame so the pipe pocket is now accessible. Insert a cover pipe at the first middle rib from the front and the first middle rib from the rear so that it is inserted in the pipe pocket on both ends of the pipe but the center of the pipe is exposed. For long buildings it may be necessary to use additional pipes in the middle. Fig. 10B

3. Tie the rope on each of the exposed pipes and throw the other end of the rope over the frame. Fig. 10C

4. Move to the other side of the frame and pull the cover over the frame with the rope. This may require two or more people. Fig. 10D

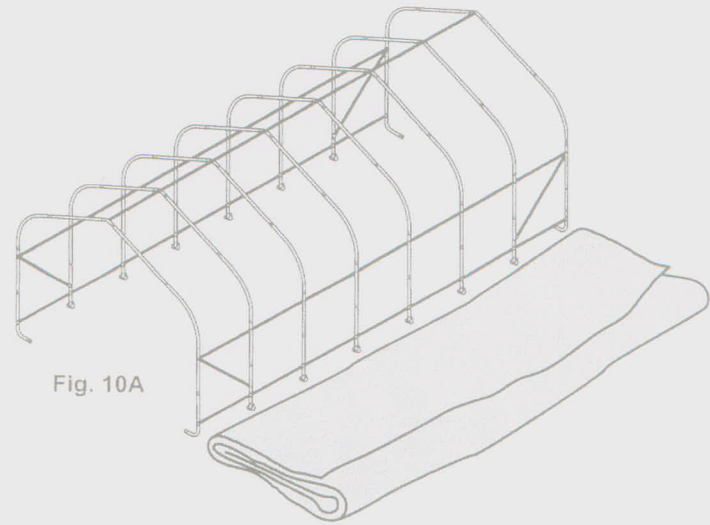

Fig. 10A

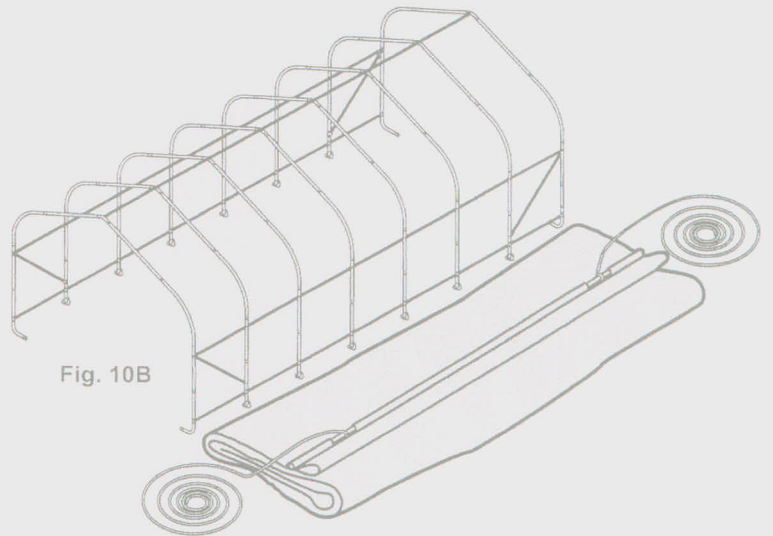

Fig. 10B

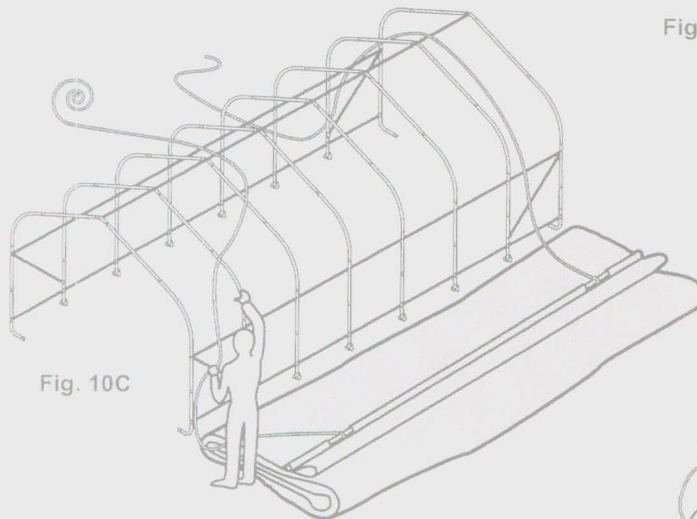

Fig. 10C

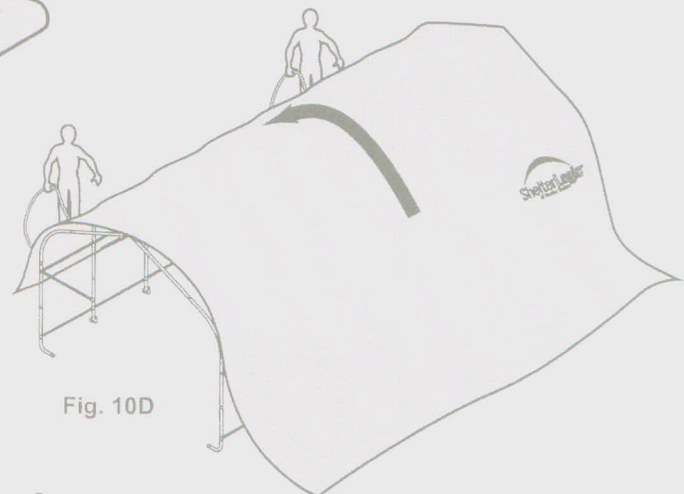

Fig. 10D

STEP 11: SECURE YOUR COVER

Fig. 11A, 11B, 12 & 13

Install the "S"-hook from the ratchet assembly into the legs of the shelter. Pull the webbing carefully to remove the slack from the cover. Be careful not to pull the webbing through the opposite side of the cover. Insert the webbing through the spindle of the ratchet and pull tight. Wind the ratchet until the webbing overlaps itself. Repeat these steps on the opposite side. Repeat this on the back side of the shelter. When all of the corners are secured move the cover front to back so that it is centered. When the cover is centered tighten all of the ratchets. Do this in an "X" pattern to be sure it is tightened evenly. Fig. 11A & 11B. When the cover is tight from end to end install the 45" cover rails. Insert the cover rails into the pockets of the cover. Clamp the rails to the ribs using the 3-way and 4-way clamps as shown in Fig. 12 & 13.

Check that the rails are evenly spaced above the ground on both sides. Push down on the connectors, one at a time, to tighten the cover. Tighten the bolts to the cover in place and tight on the frame.

Outside Corner View

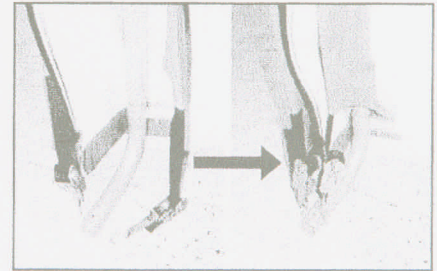
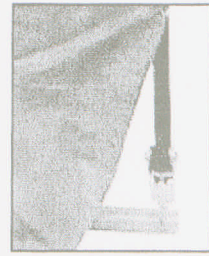

Fig. 11A

COVER TIGHTENING TIP

Check and tighten Ratchets and Cross Rails monthly to ensure the cover is tight.

IS YOUR COVER PULLED CORRECTLY ON THE FRAME?

Fig. 11B

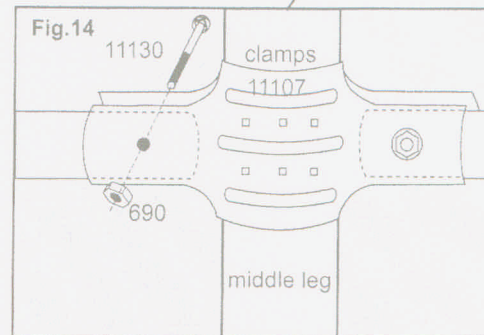
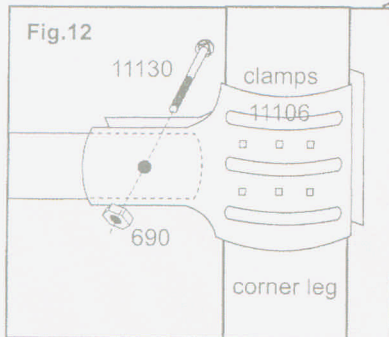
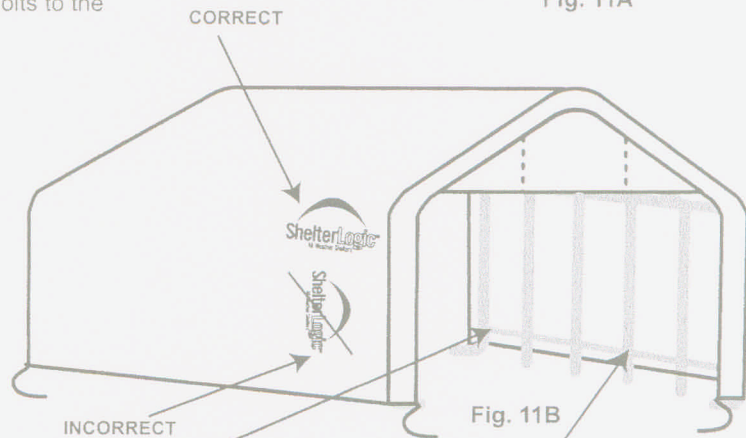

NOTE: ShelterLogic logo should line up on the left front and right rear corners near the top rail. If it is not legible and positioned as shown above as "incorrect", the cover has not been put on the frame correctly.

WARNING: Serious injury to persons or property could result if cover is installed and shelter is not completed and is left unattended. Shelter must be anchored securely until completed.