

# 10' x 20'

## MAX AP CANOPY

# Assembly Instructions

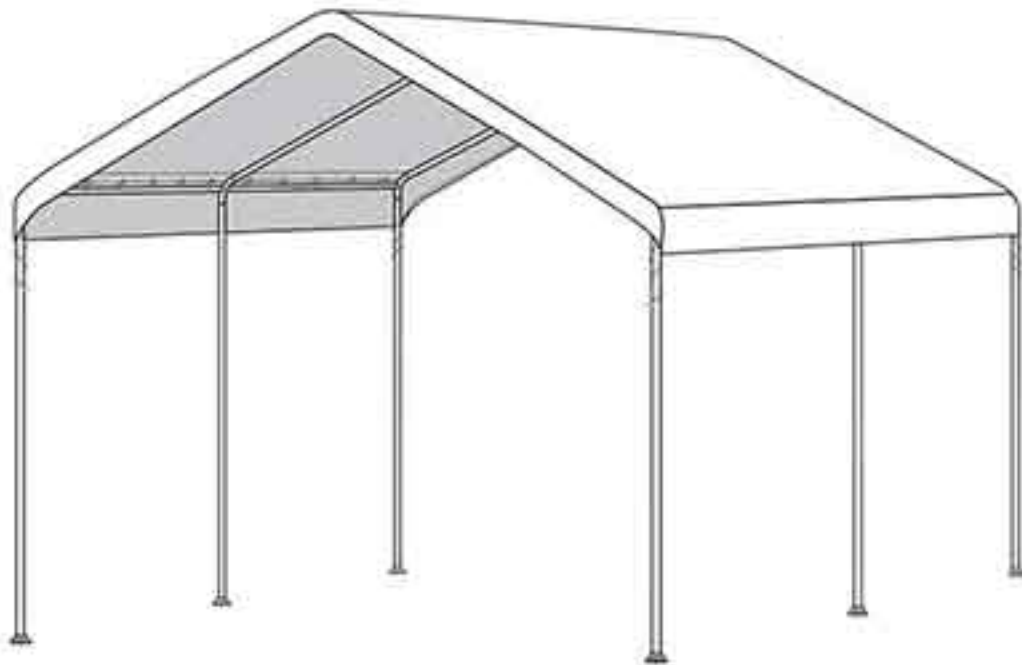

DESCRIPTION	MODEL #
10' x 20' MAX AP Canopy - 6 Leg - White	25757











### RECOMMENDED TOOLS



Please read instructions **COMPLETELY** before assembly. This shelter **MUST** be securely anchored. **THIS IS A TEMPORARY STRUCTURE AND NOT RECOMMENDED AS A PERMANENT STRUCTURE.**

Before you start: 2+ individual recommended for assembly, approximate time 2 hr.

# 10' x 20' MAX AP Canopy - 6 Leg - Parts List - Model #25757

Description of Parts:		Quantity	Part #
	Rafter Poles, Swedge 24 3/8"	6	13104
	Poles, Swedge 40 11/16"	24	13103
	Cross Poles 40 11/16"	6	13106
	Leg Poles 39"	6	13105
	3 - Way Frame Connectors	6	13101
	4 - Way Frame Connectors	3	13102
	Bungee Cords	24	10066
	Canopy Cover	1	10072
	Base Feet	6	10075
	Anchors	4	10431
	Rope 40'	1	10432

## 1. LAY OUT ROOF FRAME

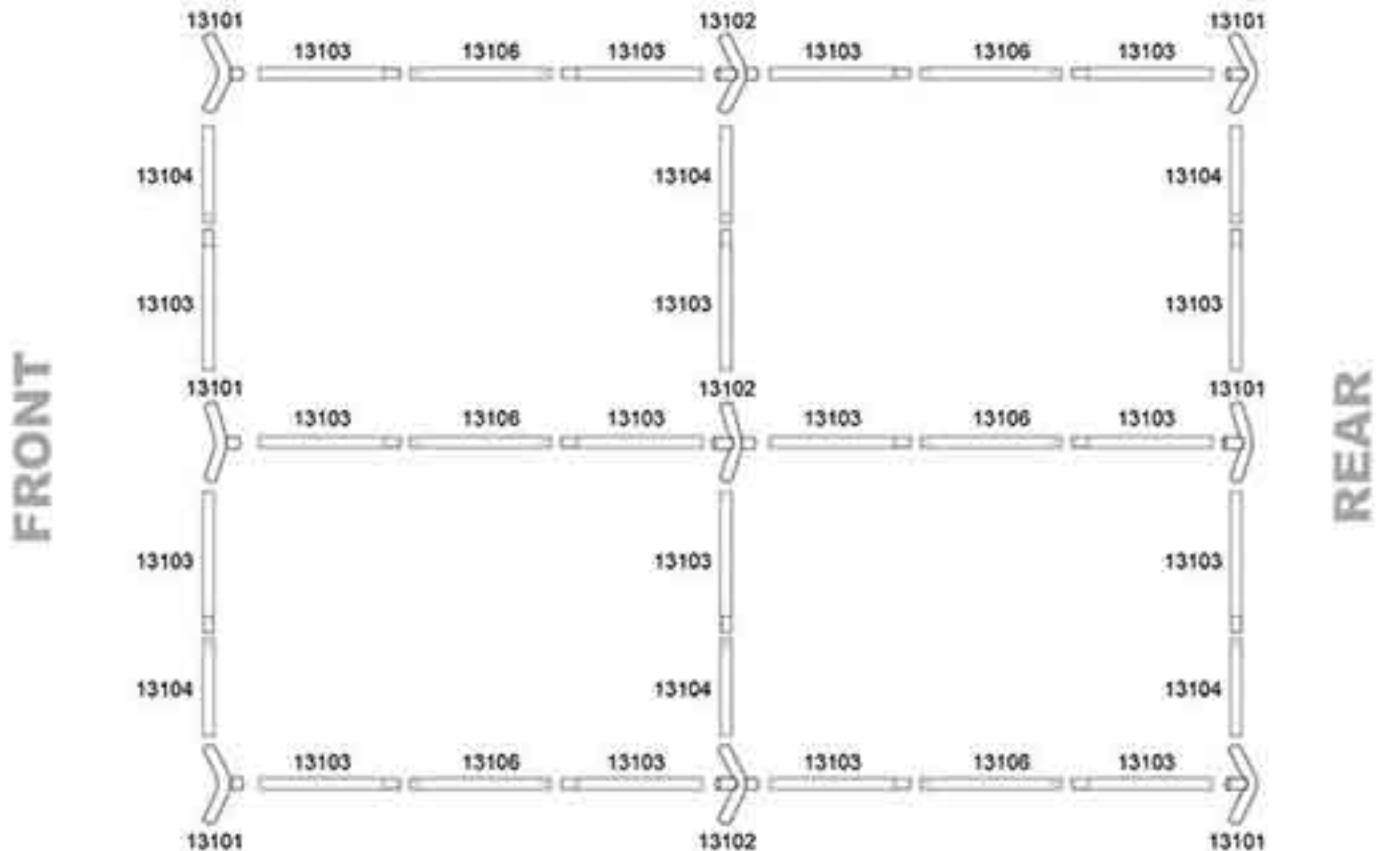

## 2. ASSEMBLE ROOF FRAME

NOTE: Swaged tubes insert into plain ends at the crimp marks.

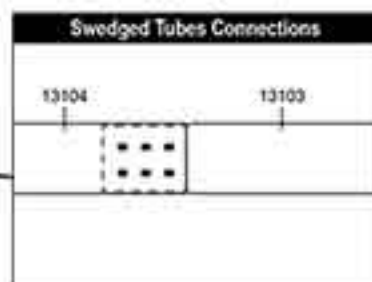
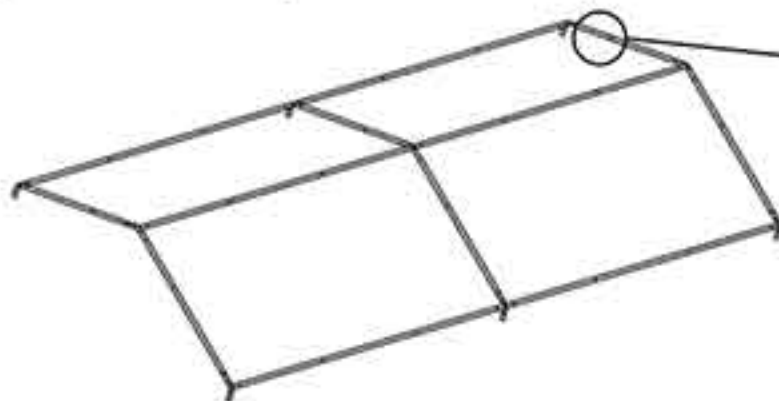

## 3. ASSEMBLE LEGS & ATTACH TO ROOF FRAME

Attach all legs to one side first. Let the other side of roof frame rest on the ground. Repeat for opposite side.

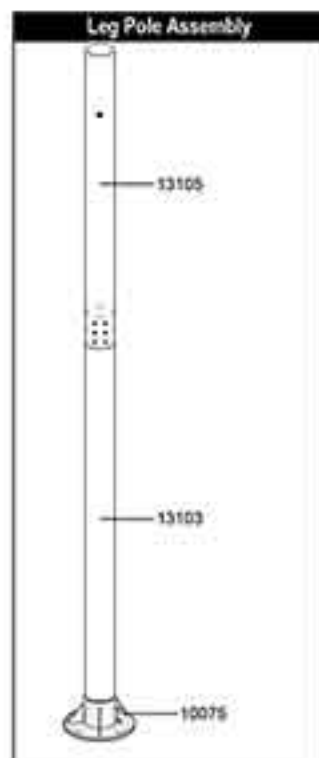
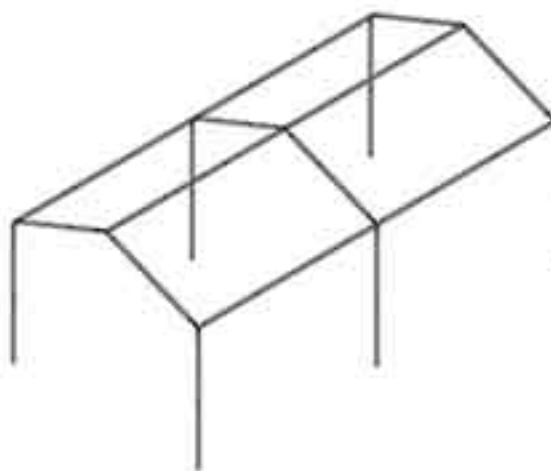
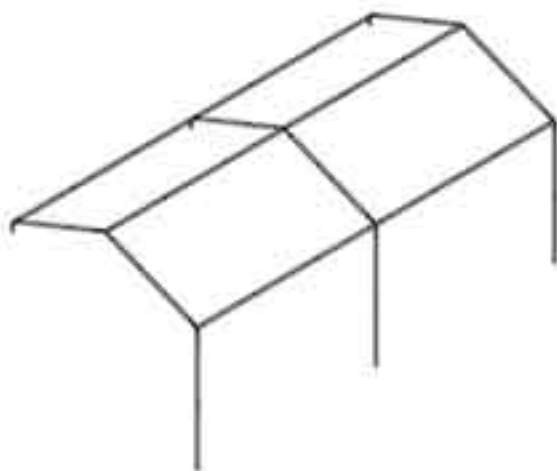

## 4. ANCHOR THE FRAME

Insert the (4) Anchor pins into the ground and tie rope from the anchors to the corner tees as shown below. *These are temporary spike anchors. Not intended for permanent use.*

To securely anchor canopy, Accessory Anchoring Kit #10073 is recommended.

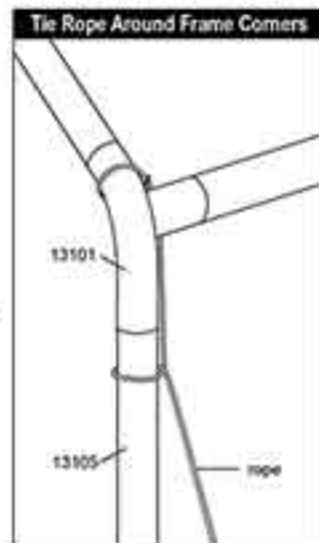
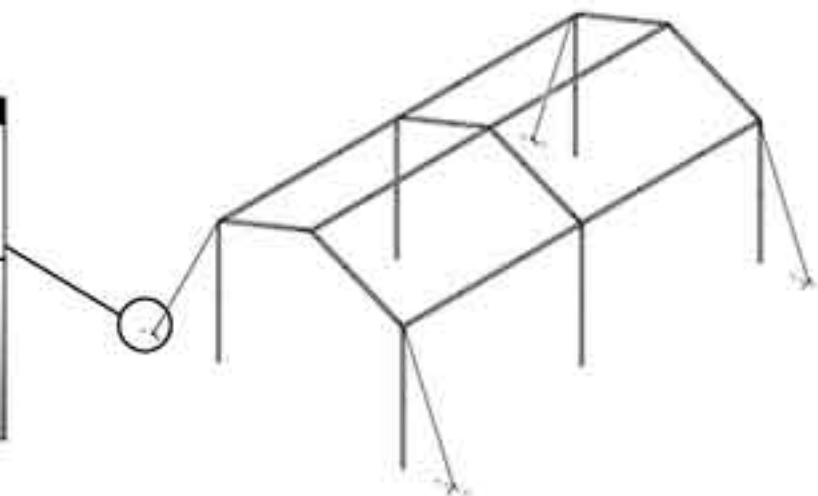

## 5. PLACE COVER AND SECURE TO CANOPY FRAME

- A. Place cover over assembled roof frame with grommet panels facing down, aligned with cross rails.
- B. Make sure the cover is properly aligned on the frame, secure the four corners of the cover with bungees (10066) to the frame first. Attach remaining bungees.
- Re-adjust bungees position along cross pole as needed to ensure a tight and even fit of the cover to the frame.*

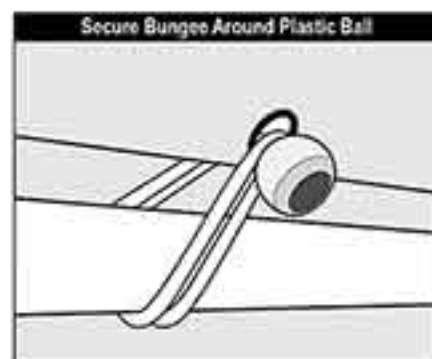
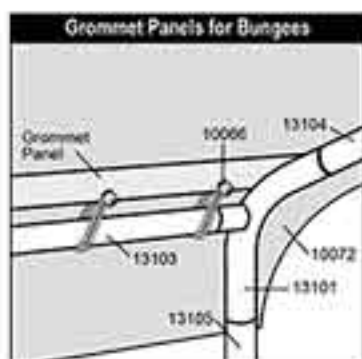
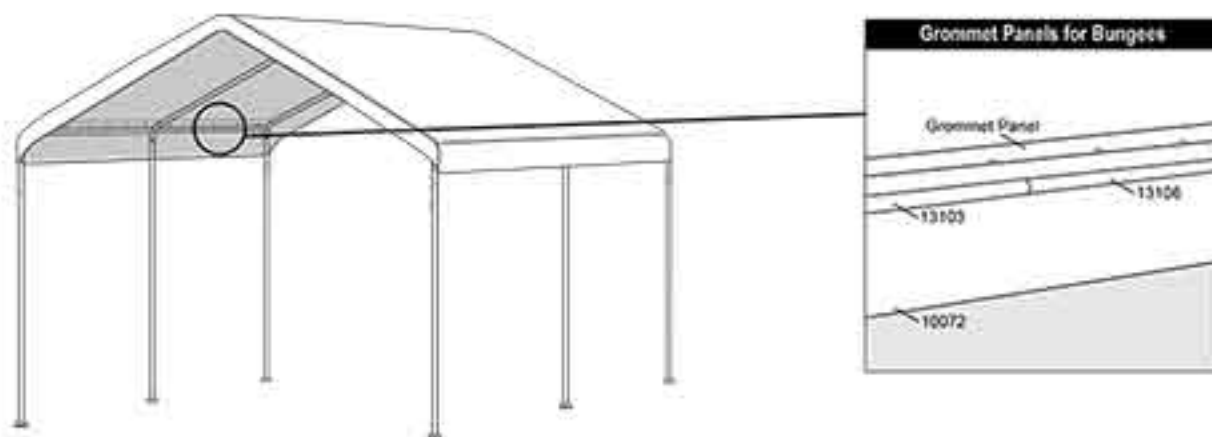

## 6. TIGHTEN THE COVER WITH TWIST TITE™

- A. Wrap the cord with plastic ball and "S" hook at the corners of the cover around the corner leg poles. Insert "S" hook into the hole of the corner leg poles.
- B. Twist each leg pole toward the inside of the shelter until the cover becomes tight. Twist the leg poles equally to ensure the cover stays aligned during tightening.

